

NEW METAL
نڤيٲٲ مٲٲٲٲ

**New Metal Factory For Aluminum
Extrusion And Powder Coating**

نظام الفورٲكس

Vortex Profile System

+966 55 3344 259

www.newmetal.com

Industrial City (Modon) - AL-Kharj - Saudi Arabia

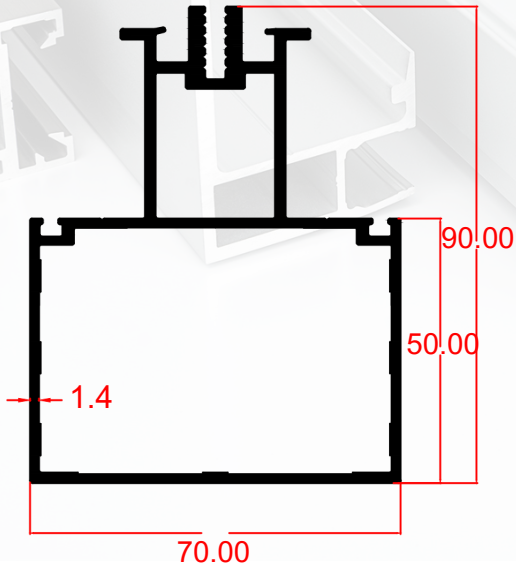

TGN 1002
WT: 2296 gr/ml

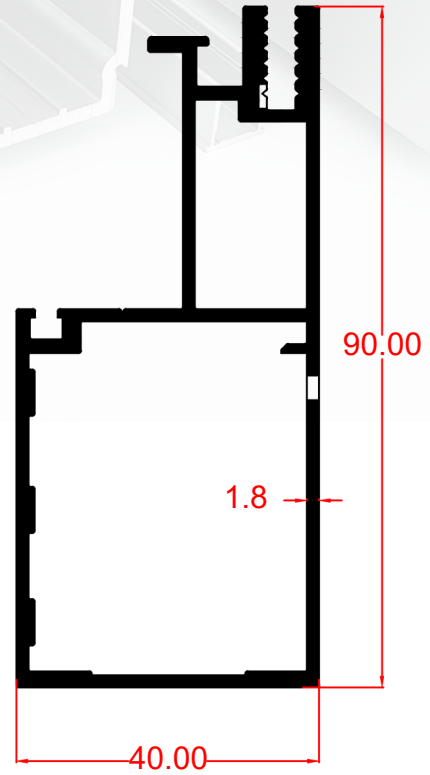

TGN 1004
WT: 1627 gr/ml

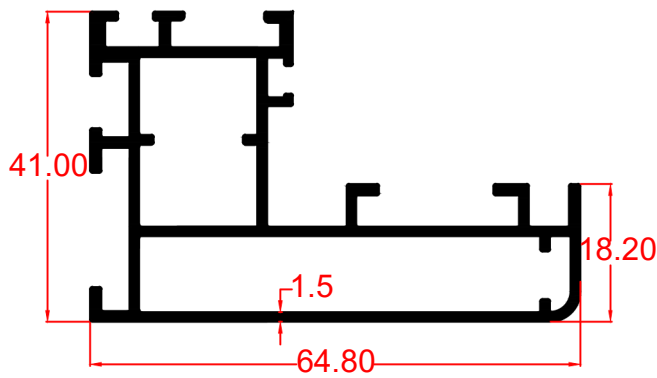

TGN 1003
WT: 1200 gr/ml

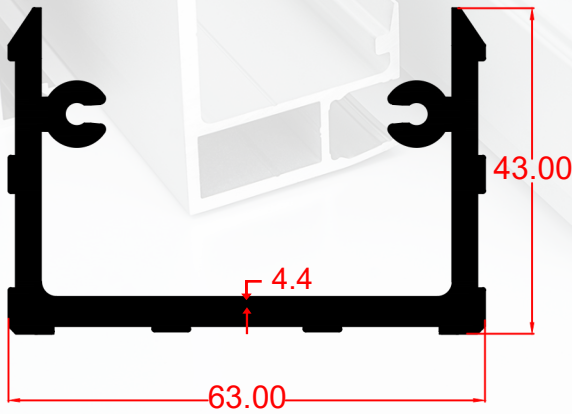

TGN 1011
WT: 1877 gr/ml

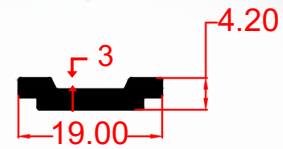

TGN 2021
WT: 171 gr/ml

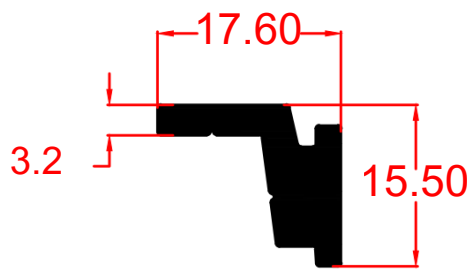

TGN 1012
WT: 347 gr/ml

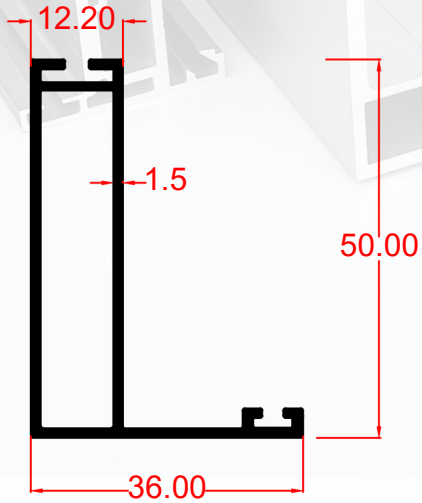

TGN 1022
 WT: 673 gr/ml

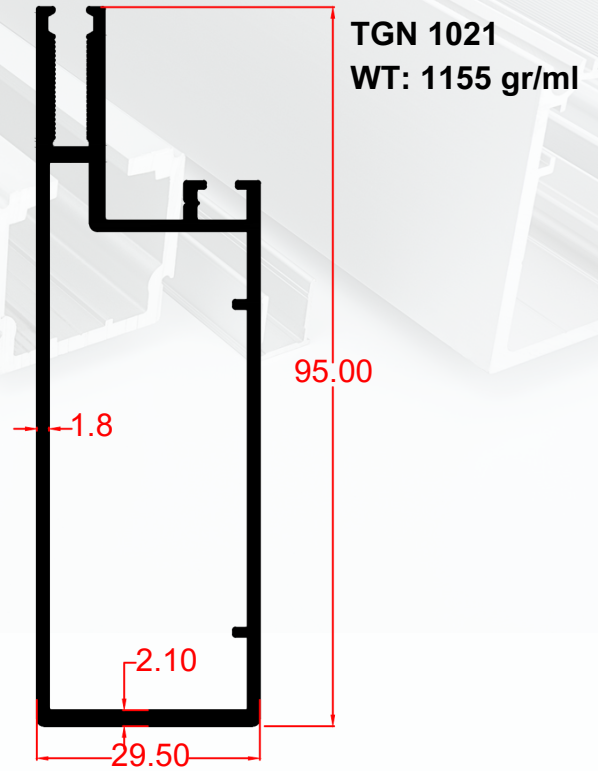

TGN 1021
 WT: 1155 gr/ml

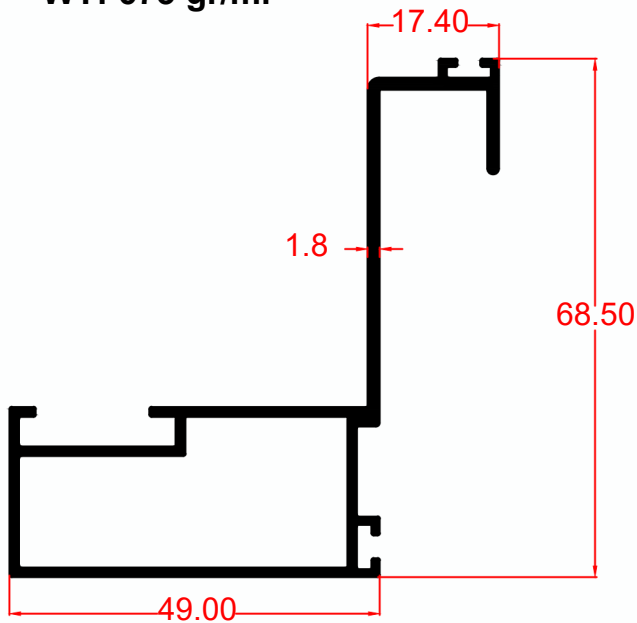

TGN 1023
 WT: 988 gr/ml

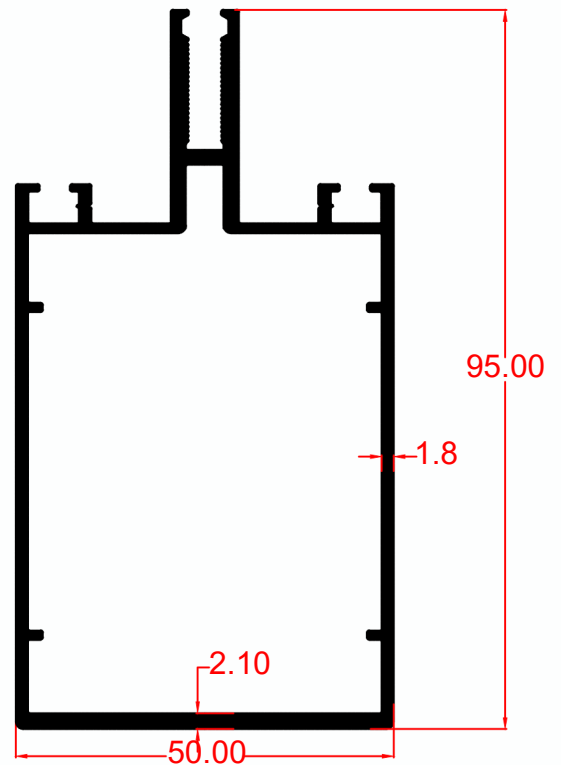

TGN 1020
 WT: 1657 gr/ml